

MAX[®]

CN665

PNEUMATIC COIL NAILER

DRUCKLUFT-COIL-NAGLER

CLOUEUSES PNEUMATIQUES
A BOBINES

SPARACHIODI AD ARIA COMPRESA
CON CARICAMENTO A ROTOLO

CLAVADORAS NEUMATICAS PARA
ROLLOS DE CLAVOS



OPERATING and MAINTENANCE MANUAL
BETRIEBSANLEITUNG
MANUEL D'UTILISATION et D'ENTRETIEN
MANUALE DI FUNZIONAMENTO E MANUTENZIONE
MANUAL DE OPERACIONES Y MANTENIMIENTO

▲ WARNING:

BEFORE USING THIS TOOL, STUDY THIS MANUAL TO ENSURE SAFETY WARNING AND INSTRUCTIONS.
KEEP THESE INSTRUCTIONS WITH THE TOOL FOR FUTURE REFERENCE.

▲ ACHTUNG!

LESEN SIE VOR INBETRIEBNAHME DES GERÄTES DIE GEBRAUCHS- UND SICHERHEITSHINWEISE. BITTE BEWAHREN SIE DIE GEBRAUCHS- UND SICHERHEITSHINWEISE AUF, DAMIT SIE AUCH SPÄTER EINGESEHEN WERDEN KÖNNEN.

▲ AVERTISSEMENT:

AVANT D'UTILISER CET OUTIL, LIRE CE MANUEL ET LES CONSIGNES DE SECURITE AFIN DE GARANTIR UN FONCTIONNEMENT SUR.
CONSERVER CE MANUEL EN LIEU SUR AVEC L'OUTIL AFIN DE POUVOIR LE CONSULTER ULTERIEUREMENT.

▲ ATTENZIONE:

PRIMA DI USARE QUESTA MACCHINA, STUDIARE IL MANUALE PER PRENDERE ATTO DEGLI AVVERTIMENTI E DELLE ISTRUZIONI PER LA SICUREZZA.
TENERE QUESTE ISTRUZIONI INSIEME ALLO STRUMENTO PER CONSULTAZIONI FUTURE

▲ ATENCIÓN:

PARA EVITAR GRAVES DAÑOS PERSONALES O EN LA PROPIEDAD.
ANTES DE EMPLEAR LA HERRAMIENTA, LEER CON ATENCIÓN Y COMPRENDER LOS SIGUIENTES INSTRUCCIONES DE SEGURIDAD.

ENGLISH

CN665

PNEUMATIC COIL NAILER

INDEX

1. SAFETY INSTRUCTIONS4
2. SPECIFICATIONS &
TECHNICAL DATA7
3. AIR SUPPLY AND CONNECTIONS ...8
4. INSTRUCTIONS FOR OPERATION ...9
5. MAINTAIN FOR PERFORMANCE ...13
6. STORING13
7. TROUBLESHOOTING/REPAIRS ...13

OPERATING and MAINTENANCE MANUAL

 **WARNING:**

BEFORE USING THIS TOOL, STUDY THIS MANUAL TO ENSURE SAFETY WARNING AND INSTRUCTIONS.

KEEP THESE INSTRUCTIONS WITH THE TOOL FOR FUTURE REFERENCE.

1. SAFETY INSTRUCTIONS



⚠ WARNING:

TO AVOID SEVERE PERSONAL INJURY OR PROPERTY DAMAGE

BEFORE USING THE TOOL, READ CAREFULLY AND UNDERSTAND THE FOLLOWING "SAFETY INSTRUCTIONS". FAILURE TO FOLLOW WARNINGS COULD RESULT IN DEATH OR SERIOUS INJURY.

PRECAUTIONS ON USING THE TOOL



1. WEAR SAFETY GLASSES OR GOGGLES

Danger to the eyes always exists due to the possibility of dust being blown up by the exhausted air or of a fastener flying up due to the improper handling of the tool. For these reasons, safety glasses or goggles shall always be worn when operating the tool.

The employer and/or user must ensure that proper eye protection is worn. Eye protection equipment must conform to the requirements of the American National Standards Institute, ANSI Z87.1 (Council Directive 89/686/EEC of 21 DEC. 1989) and provide both frontal and side protection.

The employer is responsible to enforce the use of eye protection equipment by the tool operator and all other personnel in the work area.

NOTE: Non-side shielded spectacles and face shields alone do not provide adequate protection.



2. EAR PROTECTION MAY BE REQUIRED IN SOME ENVIRONMENTS

As the working condition may include exposure to high noise levels which can lead to hearing damage, the employer and user should ensure that any necessary hearing protection is provided and used by the operator and others in the work area.



3. DO NOT USE ANY POWER SOURCE EXCEPT AN AIR COMPRESSOR

The tool is designed to operate on compressed air. Do not operate the tool on any other highpressure gas, combustible gases (e.g., oxygen, acetylene, etc.) since there is the danger of an explosion. For this reason, absolutely do not use anything other than an air compressor to operate the tool.



4. OPERATE WITHIN THE PROPER AIR PRESSURE RANGE

The tool is designed to operate within an air pressure range of 70 to 100 p.s.i. (5 to 7 bar.)

The pressure should be adjusted to the type of the work being fastened. The tool shall never be operated when the operating pressure exceeds 120 p.s.i. (8 bar.)

Never connect the tool to air pressure which potentially exceeds 200 p.s.i. (14 bar) as the tool can burst.



5. DO NOT OPERATE THE TOOL NEAR A FLAMMABLE SUBSTANCE

Never operate the tool near a flammable substance (e.g., thinner, gasoline, etc.). Volatile fumes from these substances could be drawn into the compressor and compressed together with the air and this could result in an explosion.

6. DO NOT USE A WRONG FITTINGS

The connector on the tool must not hold pressure when air supply is disconnected. If a wrong fitting is used, the tool can remain charged with air after disconnecting and thus will be able to drive a fastener even after the air line is disconnected, possibly causing injury.



7. DISCONNECT THE AIR SUPPLY AND EMPTY THE MAGAZINE WHEN THE TOOL IS NOT IN USE

Always disconnect the air supply from the tool and empty the magazine when operation has been completed or suspended, when unattended, moving to a different work area, adjusting, disassembling, or repairing the tool, and when clearing a jammed fastener.



8. INSPECT SCREW TIGHTNESS

Loose or improperly installed screws or bolts cause accidents and tool damage when the tool is put into operation. Inspect to confirm that all screws and bolts are tight and properly installed prior to operating the tool.



9. DO NOT TOUCH THE TRIGGER UNLESS YOU INTEND TO DRIVE A FASTENER

Whenever the air supply is connected to the tool, never touch the trigger unless you intend to drive a fastener into the work. It is dangerous to walk around carrying the tool with the trigger pulled, and this and similar actions should be avoided.



10. NEVER POINT THE DISCHARGE OUTLET TOWARD YOURSELF AND OTHER PERSONNEL

If the discharge outlet is pointed toward people, serious accidents may be caused when misfiring. Be sure the discharge outlet is not pointed toward people when connecting and disconnecting the hose, loading and not loading the fasteners or similar operations.

11. USE SPECIFIED FASTENERS (SEE PAGE 7)

The use of fasteners other than specified fasteners will cause the tool malfunction. Be sure to use only specified fasteners when operating the tool.



12. PLACE THE DISCHARGE OUTLET TO THE WORK PROPERLY

Failure to place the discharge outlet of the nose in a proper manner can result in a fastener flying up and is extremely dangerous.



13. KEEP HANDS AND BODY AWAY FROM THE DISCHARGE OUTLET

When loading and using the tool, never place a hand or any part of body in fastener discharge area of the tool. It is very dangerous to hit the hands or body by mistake.



14. DO NOT DRIVE FASTENERS CLOSE TO THE EDGE AND CORNER OF THE WORK AND THIN MATERIAL

The workpiece is likely to split and the fastener could fly free and hit someone.



15. DO NOT DRIVE FASTENERS ON THE TOP OF OTHER FASTENERS

Driving fasteners on the top of other fasteners may cause deflection fasteners which could cause injury.

16. REMOVING THE FASTENERS AFTER COMPLETING OPERATION

If fasteners are left in the magazine after the completion of operation, there is the danger of a serious accident occurring prior to the resumption of operation, should the tool be handled carelessly, or when connecting the air fitting. For this reason, always remove all fasteners remaining in the magazine after completion of the operation.

17. CHECK OPERATION OF THE CONTACT TRIP MECHANISM FREQUENTLY IN CASE OF USING A CONTACT TRIP TYPE TOOL

Do not use the tool if the trip is not working correctly as accidental driving of a fastener may result. Do not interfere with the proper operation of the contact trip mechanism.



18. WHEN USING THE TOOL OUTSIDE OR ELEVATED PLACE

When fastening roofs or similar slanted surface, start fastening at the lower part and gradually work your way up. Fastening backward is dangerous as you may loose your foot place. Secure the hose at a point close to the area you are going to drive fasteners. Accidents may be caused due to the hose being pulled inadvertently or getting caught.

19. NEVER USE THE TOOL IF ANY PORTION OF THE TOOL CONTROLS (e.g., TRIGGER, CONTACT ARM) IS INOPERABLE DISCONNECTED, ALTERED OR NOT WORKING PROPERLY

20. NEVER ACTUATE THE TOOL INTO FREE SPACE

This will avoid any hazard caused by free flying fasteners and excessive strain of the tool.

21. ALWAYS ASSUME THAT THE TOOL CONTAINS FASTENERS

22. RESPECT THE TOOL AS A WORKING IMPLEMENT

23. NO HORSEPLAY

24. NEVER LOAD THE TOOL WITH FASTENERS WHEN ANY ONE OF THE OPERATING CONTROLS (e.g., TRIGGER, CONTACT ARM) IS ACTIVATED

OBSERVE THE FOLLOWING GENERAL CAUTION IN ADDITION TO THE OTHER WARNINGS CONTAINED IN THIS MANUAL

- Do not use the tool as a hammer.
- Always carry the tool by handle, never carry the tool by the air hose.
- The tool must be used only for the purpose it was designed.
- Never remove, tamper with the operating controls (e.g., TRIGGER, CONTACT ARM)
- Keep the tool in a dry place out of reach of children when not in use.
- Do not use the tool without Safety Warning label.
- Do not modify the tool from original design or function without approval by MAX CO., LTD.

2. SPECIFICATIONS AND TECHNICAL DATA

1. NAME OF PARTS

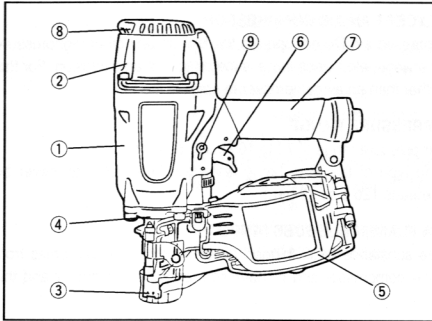

- ① Frame
- ② Cylinder Cap
- ③ Contact Arm
- ④ Nose
- ⑤ Magazine
- ⑥ Trigger
- ⑦ Grip
- ⑧ Exhaust Cover
- ⑨ Trigger Lock Dial

2. TOOL SPECIFICATIONS

PRODUCT NO.	CN665
HEIGHT	12-5/8" (321 mm)
WIDTH	5" (130 mm)
LENGTH	11" (280 mm)
WEIGHT	6.2 lbs. (2.8 kg)
RECOMMENDED OPERATING PRESSURE	70 to 100 p.s.i. (5 to 7 bar)
LOADING CAPACITY	300 Nails
AIR CONSUMPTION	1.20 l at 90 p.s.i. (6 bar) operating pressure

3. FASTENER SPECIFICATIONS

PRODUCT NO.	CN665
NAIL LENGTH	1-1/2" to 2-1/2" (38 to 65 mm)
SHANK DIAMETER	.080" to .131" (ϕ 2.3 to ϕ 3.3 mm)
SHANK TYPE	Smooth, Ring, Screw
HEAD DIAMETER	.236" to .276" (ϕ 6.0 to ϕ 7.0 mm)

TOOL AIR FITTINGS:

This tool uses a 1/4" N.P.T. male plug. The inside diameter should be .28" (7mm) or larger. The fitting must be capable of discharging tool air pressure when disconnected from the air supply.

RECOMMENDED OPERATING PRESSURE:

70 to 100 p.s.i. (5 to 7 bar). Select the operating air pressure within this range for best fastener performance.

DO NOT EXCEED 120 p.s.i. (8 bar).

4. TECHNICAL DATA

① NOISE

A-weighted single-event ----- LWA, 1s, d 94.45 dB
sound power level

A-weighted single-event ----- LpA, 1s, d 88.00 dB
emission sound pressure
level at work station

These values are determined and documented in accordance to EN12549 : 1999.

② VIBRATION

Vibration characteristic value = 3.84 m/s²

These values are determined and documented in accordance to ISO 8662-11.

This value is a tool-related characteristic value and does not represent the influence to the hand-arm-system when using the tool. An influence to the hand-arm-system when using the tool will for example depend on the gripping force, the contact pressure force, the working direction, the adjustment of mains supply, the workpiece, the workpiece support.

5. APPLICATIONS

*General construction works including panel sheathing, decking, subflooring, siding

▲ WARNING:

3. AIR SUPPLY AND CONNECTIONS

Read section titled “SAFETY INSTRUCTIONS”.



DO NOT USE ANY POWER SOURCE EXCEPT AN AIR COMPRESSOR

The tool is designed to operate on compressed air. Do not operate the tool on any other high-pressure gas, combustible gases (e.g., oxygen, acetylene, etc.) since there is the danger of an explosion. For this reason, absolutely do not use anything other than an air compressor to operate the tool.



OPERATE WITHIN THE PROPER AIR PRESSURE RANGE

The tool designed to operate within an air pressure range of 70 to 100 p.s.i. (5 to 7 bar.) The pressure should be adjusted to the type of the work being fastened. The tool shall never be operated when the operating pressure exceeds 120 p.s.i. (8 bar.)



DO NOT OPERATE THE TOOL NEAR A FLAMMABLE SUBSTANCE

Never operate the tool near a flammable substance (e.g., thinner, gasoline, etc.). Volatile fumes from these substances could be drawn into the compressor and compressed together with the air and this could result in an explosion.

DO NOT USE A WRONG FITTINGS

The connector on the tool must not hold pressure when air supply is disconnected. If a wrong fitting is used, the tool can remain charged with air after disconnecting and thus will be able to drive a fastener even after the air line is disconnected, possibly causing injury.



DISCONNECT THE AIR SUPPLY AND EMPTY THE MAGAZINE WHEN THE TOOL IS NOT IN USE

Always disconnect the air supply from the tool and empty the magazine when operation has been completed or suspended, when unattended, moving to a different work area, adjusting, disassembling, or repairing the tool, and when clearing a jammed fastener.

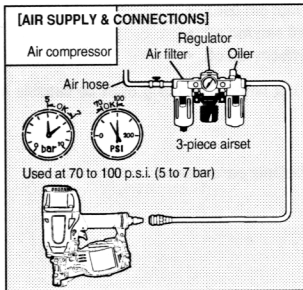

FITTINGS: Install a male plug on the tool which is free flowing and which will release air pressure from the tool when disconnected from the supply source.

HOSES: Hose has a min. ID of 1/4" (6 mm) and max. length of no more than 17' (5 meters).

The supply hose should contain a fitting that will provide "quick disconnecting" from the male plug on the tool.

SUPPLY SOURCE: Use only clean regulated compressed air as a power source for the tool.

3-PIECE AIRSET (Air filter, Regulator, Oiler):

Refer to **TOOL SPECIFICATIONS** for setting the correct operating pressure for the tool.

NOTE:

A filter will help to get the best performance and minimum wear from the tool because dirt and water in the air supply are major causes of wear in the tool.

Frequent, but not excessive, lubrication is required for the best performance. Oil added thru the air line connection will lubricate the internal parts.

4. INSTRUCTIONS FOR OPERATION

Read section titled "SAFETY INSTRUCTIONS".

1. BEFORE OPERATION

- ① Wear Safety Glasses or Goggles.
- ② Do not connect the air supply.
- ③ Inspect screw tightness.
- ④ Check operation of the contact arm & trigger if moving smoothly.
- ⑤ Connect the air supply.
- ⑥ Check the air-leakage. (The Tool must not have the air-leakage.)
- ⑦ Hold the Tool with finger-off the trigger, then push the contact arm against the work-piece. (The tool must not operate.)
- ⑧ Hold the Tool with contact arm free from work-piece and pull the trigger. (The Tool must not operate.)
- ⑨ Disconnect the air supply.

2. OPERATION

Wear safety glasses or goggles danger to the eyes always exists due to the possibility of dust being blown up by the exhausted air or of a fastener flying up due to the improper handling of the tool. For these reasons, safety glasses or goggles shall always be worn when operating the tool.

The employer and/or user must ensure that proper eye protection is worn. Eye protection equipment must conform to the requirements of the American National Standards Institute, ANSI Z87.1 (Council Directive 89/686/EEC of 21 DEC. 1989) and provide both frontal and side protection.

The employer is responsible to enforce the use of eye protection equipment by the tool operator and all other personnel in the work area.

NOTE: Non-side shielded spectacles and face shields alone do not provide adequate protection.

▲ WARNING:



▲ WARNING:



Keep hands and body away from the discharge outlet when driving the fasteners because of dangerous of hitting the hands or body by mistake.

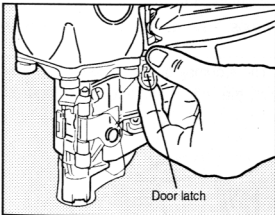

NAIL LOADING

- ① Open the magazine:
Hold door and door latch by fingers and pull up door latch. Swing door open. Swing magazine cover open.

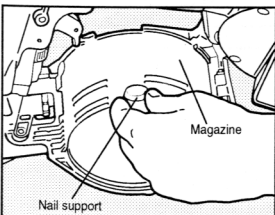

- ② Check adjustment:
The nail support can be moved up and down to four settings. To change setting pull up on the post and twist to the correct step. The nail support should be adjusted correctly to the position indicated in inches and millimeters inside magazine.

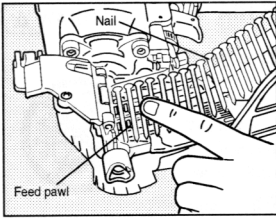

③ Nail loading:

Place a coil of nails over the post in the magazine. Uncoil enough nails to reach the feed pawl, and place the second nail between the teeth on the feed pawl. The nail heads fit in slot on nose.

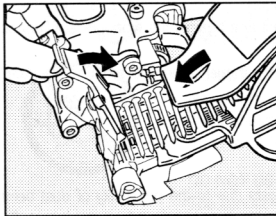

④ Swing cover closed.

⑤ Close the door.

Check that latch engages. (If it does not engage, check that the nail heads are in the slot on the nose).

TEST OPERATION

① Adjust the air pressure at 70 p.s.i. (5 bar) and connect the air supply.

② Without touching the trigger, depress the contact arm against the work-piece.

Pull the trigger. (The tool must fire the fastener.)

③ With the tool off the work-piece, pull the trigger.

Then depress the contact arm against the work-piece.

(The tool must fire the fastener.)

④ Adjust the air pressure as much as the lowest possible according to the diameters and length of fastener and the hardness of work-piece.

MODEL IDENTIFICATION

CONTACT TRIP

The common operating procedure on "Contact Trip" tools is for the operator to contact the work to actuate the trip mechanism while keeping the trigger pulled, thus driving a fastener each time the work is contacted. This will allow rapid fastener placement on many jobs, such as sheathing, decking and pallet assembly.

All pneumatic tools are subject to recoil when driving fasteners. The tool may bounce, releasing the trip, and if unintentionally allowed to recontact the work surface with the trigger still actuated (finger still holding trigger pulled) an unwanted second fastener will be driven.



CONTACT TRIP

Identified by **BLACK TRIGGER**.

SEQUENTIAL TRIP

The Sequential Trip requires the operator to hold the tool against the work before pulling the trigger. This makes accurate fastener placement easier, for instance on framing, toe nailing and crating applications. The Sequential Trip allows exact fastener location without the possibility of driving a second fastener on recoil, as described under "Contact Trip".

The Sequential Trip Tool has a positive safety advantage because it will not accidentally drive a fastener if the tool is contacted against the work-or anything else-while the operator is holding the trigger pulled.

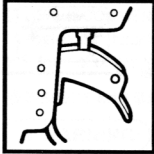

SEQUENTIAL TRIP

Identified by **ORANGE TRIGGER**.

DRIVING FASTENERS

CONTACT FIRE OPERATION (CONTACT TRIP)

For contact fire operation, hold the trigger and depress the contact arm against the work surface.

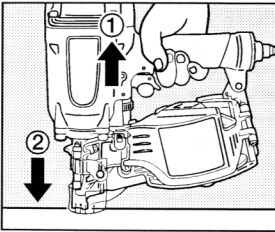

PROCEDURE

- ① Hold the trigger.
- ② Depress the contact arm.

SINGLE FIRE OPERATION (ANTI-DOUBLE FIRE MECHANISM AND SEQUENTIAL TRIP)

For single fire operation, depress the contact arm against the work surface and pull the trigger. Tool can not fire a second nail until the trigger is released and tool can cycle.

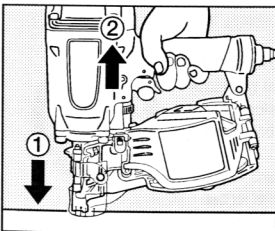

PROCEDURE

- ① Depress the contact arm.
- ② Pull the trigger.

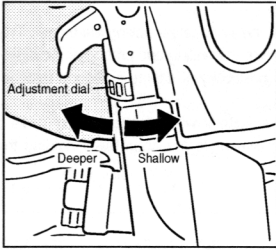

DRIVING DEPTH ADJUSTMENT DIAL

▲ WARNING:

ALWAYS disconnect air supply before adjustment dial.

- ① With air pressure set, drive nails into a representative material sample to determine if adjustment is necessary.
- ② If adjustment is required, disconnect air supply.
- ③ Refer to the mark on the contact arm for direction to turn the adjustment dial.
- ④ Reconnect air supply.

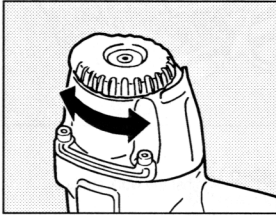
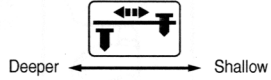

DIRECTIONAL EXHAUST COVER

▲ WARNING:

ALWAYS disconnect air supply before rotating the exhaust cover.

Direction of the exhaust air is changeable by rotating exhaust cover by hand.

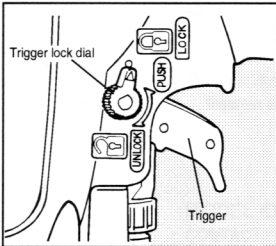

TRIGGER LOCK MECHANISM

The tool is equipped with a trigger lock mechanism. Push and rotate the trigger LOCK to the trigger UNLOCK position before driving nails.

5. MAINTAIN FOR PERFORMANCE

❶ DO NOT FIRE THE NAILER WHEN IT IS EMPTY

❷ USE A 3-PIECE AIRSET

Failure to use a 3-piece airset allows the moisture and dirt inside compressor to pass into the tool directly. This causes rust and wear, and results in a poor operating performance. The hose length between airset and tool should be no longer than 5 m since a longer length results in a reduction in air pressure.

❸ USE RECOMMENDED OIL

The velocity or turbine oil should be used to lubricate the tool. Upon completion of operations, place 2 or 3 drops of oil into the air plug inlet with the jet oiler. (Recommended Oil : ISO VG32)

❹ INSPECT AND MAINTAIN DAILY OR BEFORE OPERATION

WARNING:

Disconnect air supply and empty the magazine when inspecting or maintaining the tool.

- (1) Drain air line filter and compressor
- (2) Keep lubricator filled in air 3-pieces set
- (3) Clean filter element of air 3-pieces set
- (4) Tighten all screws
- (5) Keep contact arm moving smoothly

6. STORING

- ❶ When not in use for an extended period, apply a thin coat of the lubricant to the steel parts to avoid rust.
- ❷ Do not store the tool in a cold weather environment. Keep the tool in a warm area.
- ❸ When not in use, the tool should be stored in a warm and dry place. Keep out of reach of children.
- ❹ All quality tools will eventually require servicing or replacement of parts because of wear from the normal use.

7. TROUBLE SHOOTING/REPAIRS

The troubleshooting and/or repairs shall be carried out only by the MAX CO., LTD. authorised distributors or by other specialists.



Supplement to the operating instruction

According to the European Norm EN 792-13 the regulation is valid from 01.01.2001 that all fastener driving tools with contact actuation must be marked with the symbol "Do not use on scaffoldings, ladders" and they shall not be used for specific application for example:

- * when changing one driving location to another involves the use of scaffoldings, stairs, ladders or ladder alike constructions e.g. roof laths,
- * closing boxes or crates,
- * fitting transportation safety systems e.g. on vehicles and wagons.